

DECLARACIÓN DE PRESTACIONES

Nº 16510-24073

	Modelo:	Laris 80 LI
	Código:	M7046
	Aplicación de uso del artículo:	Calefacción en edificios residenciales
	Nombre del fabricante:	Manufacturas Rocal S.A
	Dirección del fabricante:	Raval Sant Antoni, 2, (08540) Centelles, España
Sistema EVCP:	Sistema 3	
Laboratorio notificado:	Kiwa Cermet Italia	
Especificación técnica armonizada:	EN 16510-1:2022, EN 16510-2-2:2022	
Informe número:	0476-AoP-CPR-2014280	

Características esenciales

Estabilidad y resistencia mecánica

Capacidad portante: 0 kg

Seguridad contra incendios - protección de elementos inflamables

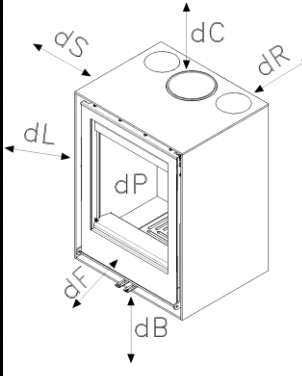
Distancia mínima de materiales combustibles - base (dB):	350 mm	
Distancia mínima de materiales combustibles - suelo frontal (dF):	1500 mm	
Distancia mínima de materiales combustibles - techo (dC):	750 mm	
Distancia mínima de materiales combustibles - posterior (dR):	250 mm	
Distancia mínima de materiales combustibles - lateral (dS1):	900 mm	
Distancia mínima de materiales combustibles - lateral (dS2):	380 mm	
Distancia mínima de materiales combustibles - radiación lateral (dL1):	0 mm	
Distancia mínima de materiales combustibles - radiación lateral (dL2):	1500 mm	
Distancia mínima de materiales combustibles - radiación frontal (dP):	1100 mm	
Espesor material protector aislante:	-	
Conductividad térmica material protector aislante (λ_d):	-	
Clase de conducto para la salida de humos:	T400G	

Prestaciones - emisiones:

Potencia Nominal

Potencia Reducida

Monóxido de Carbono (CO al 13% de O ₂):	907 mg/m ³	2781 mg/m ³
Óxidos de Nitrogeno (NO _x al 13% de O ₂):	99 mg/m ³	89 mg/m ³
Compuestos orgánicos volátiles (OGC al 13% de O ₂):	47 mg/m ³	230 mg/m ³
Emisión de partículas (PM al 13% de O ₂):	14 mg/m ³	30 mg/m ³

Prestaciones - Potencia y rendimiento:

Potencia Nominal

Potencia Reducida

Potencia nominal al ambiente:	6,90 kW	4,60 kW
Rendimiento:	86,8 %	80,3 %

Datos de la instalación de la chimenea:

Potencia Nominal

Potencia Reducida

Temperatura de humos:	244,4 °C	234,8 °C
Tiraje mínimo:	11,7 Pa	11,4 Pa
Caudal másico:	4,7 g/s	-

Eficiencia en calentar el espacio

Rendimiento Estacional:	77 %
Índice de Eficiencia Energética:	116
Clasificación Energética:	A+
Consumo eléctrico a Potencia Nominal:	-
Consumo eléctrico a Potencia Parcial:	-
Consumo eléctrico en espera:	-

Utilización sostenible de los recursos naturales:

Información de la sostenibilidad ambiental:	NPD
---	-----

Las prestaciones del producto anteriormente identificado son conformes al conjunto de las prestaciones declaradas. La presente declaración de prestaciones se emite de conformidad con el Reglamento (UE) n.º 305/2011, bajo la responsabilidad del fabricante anteriormente identificado.

Firmado por y en nombre del fabricante por:

Ramon Roma Viñets

Administrador



Centelles, 19/01/2026

DECLARATION OF PERFORMANCE

N° 16510-24073

	Modèle :	Laris 80 LI
	Code:	M7046
	Intended use of the product:	Space heating in residential buildings
	Manufacturer name:	Manufacturas Rocal S.A
	Manufacturer direction:	Raval Sant Antoni, 2, (08540) Centelles, España
	Sistem AVCP:	System 3
	Notified body:	Kiwa Cermet Italia
Harmonized technical specification:	EN 16510-1:2022, EN 16510-2-2:2022	
Test report number:	0476-AoP-CPR-2014280	

Essential characteristics

Stability and mechanical resistance

Bearing capacity: 0 kg

Fire safety - protection of flammable elements

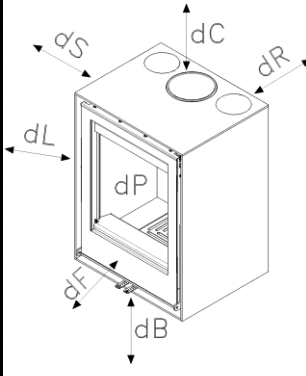
Minimum distance from combustible materials - base (dB):	350 mm	
Minimum distance from combustible materials - front floor (dF):	1500 mm	
Minimum distance from combustible materials - ceiling (dC):	750 mm	
Minimum distance from combustible materials - rear (dR):	250 mm	
Minimum distance from combustible materials - side (dS1):	900 mm	
Minimum distance from combustible materials - side (dS2):	380 mm	
Minimum distance from combustible materials - lateral radiation (dL1):	0 mm	
Minimum distance from combustible materials - lateral radiation (dL2):	1500 mm	
Minimum distance from combustible materials - front radiation (dP):	1100 mm	
Thickness of insulating protective material:	-	
Thermal conductivity of insulating protective material (λd):	-	
Class of smoke duct:	T400G	

Performance - emissions:

	Nominal Power	Reduced Power
Carbon monoxid (CO at 13% of O ₂):	907 mg/m ³	2781 mg/m ³
Nitrogen Oxides (NO _x at 13% of O ₂):	99 mg/m ³	89 mg/m ³
Volatile organic compounds (VOC at 13% of O ₂):	47 mg/m ³	230 mg/m ³
Particle emission (PM at 13% of O ₂):	14 mg/m ³	30 mg/m ³

Performance - Power and efficiency:

	Nominal Power	Reduced Power
Potencia nominal al ambiente:	6,90 kW	4,60 kW
Efficiency:	86,8 %	80,3 %

Flue pipe installation data:

	Nominal Power	Reduced Power
Smoke temperature:	244,4 °C	234,8 °C
Minimum draft:	11,7 Pa	11,4 Pa
Mass flow rate:	4,7 g/s	-

Space heating efficiency

Stational efficiency:	77 %
Energetic efficiency index:	116
Energetic classification:	A+
Electrical consumption at nominal power:	-
Electrical consumption at reduced power:	-
Electrical consumption in stand-by:	-

Sustainable use of natural resources:

Environmental sustainability information:	NPD
---	-----

The performance of the product identified above is in accordance with all the declared performances. This declaration of performance is issued in accordance with Regulation (EU) No. 305/2011, under the responsibility of the manufacturer identified above.

Signed by and on behalf of the manufacturer by:

Ramon Roma Viñets

Administrator



Centelles, 19/01/2026

DECLARATION DE PERFORMANCE

N° 16510-24073

	Model:	Laris 80 LI
	Code:	M7046
	Usage prévu de l'article :	Chauffage des locaux dans les batiments résidentiels
	Nom du fabricant:	Manufacturas Rocal S.A
	Adresse du fabricant :	Raval Sant Antoni, 2, (08540) Centelles, España
	Système EVCP:	Système 3
Laboratoire certificateur:	Kiwa Cermet Italia	
Spécification technique harmonisée:	EN 16510-1:2022, EN 16510-2-2:2022	
Numéro du rapport de test :	0476-AoP-CPR-2014280	

Caractéristiques essentielles

Stability and mechanical resistance

Bearing capacity: 0 kg

Sécurité incendie - protection des éléments inflammables

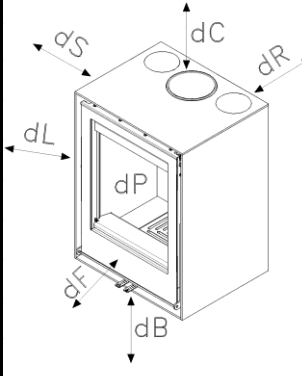
Distance minimale aux matériaux combustibles - base (dB):	350 mm	
Distance minimale aux matériaux combustibles - plancher avant (dF):	1500 mm	
Distance minimale aux matériaux combustibles – plafond (dC):	750 mm	
Distance minimale aux matériaux combustibles – arrière (dR):	250 mm	
Distance minimale aux matériaux combustibles – côté (dS1):	900 mm	
Distance minimale aux matériaux combustibles – côté (dS2) :	380 mm	
Distance minimale aux matériaux combustibles – rayonnement latéral (dL1) :	0 mm	
Distance minimale aux matériaux combustibles – rayonnement latéral (dL2) :	1500 mm	
Distance minimale aux matériaux combustibles – rayonnement frontal (dP) :	1100 mm	
Épaisseur du matériau de protection isolant :	-	
Conductivité thermique du matériau de protection isolant (λd):	-	
Classe du conduit de fumée :	T400G	

Performance - émissions:

Puissance nominale

Puissance réduite

Monoxyde de carbone (CO à 13 % O ₂):	907 mg/m ³	2781 mg/m ³
Oxydes d'azote (NOx à 13 % O ₂):	99 mg/m ³	89 mg/m ³
Composés organiques volatils (COV à 13 % O ₂):	47 mg/m ³	230 mg/m ³
Émission de particules (PM à 13 % O ₂):	14 mg/m ³	30 mg/m ³

Performance – Puissance et rendement :

Puissance nominale

Puissance réduite

Puissance nominale à l'ambiance :	6,90 kW	4,60 kW
Rendement:	86,8 %	80,3 %

Données d'installation du conduit de fumée:

Puissance nominale

Puissance réduite

Température des fumées :	244,4 °C	234,8 °C
Tirage minimum :	11,7 Pa	11,4 Pa
Débit massique :	4,7 g/s	-

Rendement de chauffage de l'espace

Rendement saisonnier :	77 %
Indice d'efficacité énergétique:	116
Classification énergétique:	A+
Consommation électrique à puissance nominale:	-
Consommation électrique à puissance réduite:	-
Consommation électrique en veille:	-

Utilisation durable des ressources naturelles:

Informations sur la durabilité environnementale:	NPD
--	-----

Les performances du produit identifié ci-dessus sont conformes à toutes les performances déclarées. Cette déclaration de performance est établie conformément au Règlement (UE) n° 305/2011, sous la responsabilité du fabricant identifié ci-dessus.

Signé par et pour le compte du fabricant :

Ramon Roma Viñets

Administrateur



Centelles, 19/01/2026

	Modello:	Laris 80 LI
	Codice:	M7046
	Uso previsto del prodotto:	Riscaldamento ambienti residenziali
	Nome del produttore:	Manufacturas Rocal S.A
	Indirizzo del produttore:	Raval Sant Antoni, 2, (08540) Centelles, España
	Sistema AVCP:	Sistema 3
	Ente Notificato:	Kiwa Cermet Italia
	Specifica tecnica armonizzata:	EN 16510-1:2022, EN 16510-2-2:2022
	Numero rapporto di prova:	0476-AoP-CPR-2014280

CARATTERISTICHE ESSENZIALI

Stabilità e resistenza meccanica

Capacità di carico: 0 kg

Sicurezza antincendio - protezione da materiali combustibili

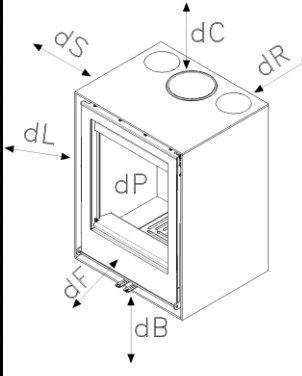
Distanza minima da materiali combustibili - sotto (dB):	350 mm	
Distanza minima da materiali combustibili - pavimento frontale (dF):	1500 mm	
Distanza minima da materiali combustibili - soffitto (dC):	750 mm	
Distanza minima da materiali combustibili - retro (dR):	250 mm	
Distanza minima da materiali combustibili - lato (dS1):	900 mm	
Distanza minima da materiali combustibili - lato (dS2):	380 mm	
Distanza minima da materiali combustibili - irraggiamento laterale (dL1):	0 mm	
Distanza minima da materiali combustibili - irraggiamento laterale (dL2):	1500 mm	
Distanza minima da materiali combustibili - irraggiamento frontale (dP):	1100 mm	
Spessore materiale isolante protettivo:	-	
Conducibilità termica materiale isolante protettivo (λd):	-	
Classe di temperatura camino:	T400G	

Prestazioni - Emissioni:

Potenza nominale

Potenza ridotta

Carbon monoxid (CO at 13% of O ₂):	907 mg/m ³	2781 mg/m ³
Nitrogen Oxides (NO _x at 13% of O ₂):	99 mg/m ³	89 mg/m ³
Volatile organic compounds (VOC at 13% of O ₂):	47 mg/m ³	230 mg/m ³
Particle emission (PM at 13% of O ₂):	14 mg/m ³	30 mg/m ³

Prestazioni - Potenza e rendimento:

Potenza nominale

Potenza ridotta

Potencia nominal al ambiente:	6,90 kW	4,60 kW
Efficiency:	86,8 %	80,3 %

Dati di installazione del tubo di scarico:

Potenza nominale

Potenza ridotta

Temperatura fumi in uscita:	244,4 °C	234,8 °C
Tiraggio minimo:	11,7 Pa	11,4 Pa
Portata massica dei fum:	4,7 g/s	-

Efficienza in riscaldamento d'ambiente

Efficienza energetica stagionale	77 %
Indice di efficienza energetica	116
Classe di efficienza energetica:	A+
Assorbimento elettrico alla potenza nominale:	-
Assorbimento elettrico alla potenza ridotta	-
Assorbimento elettrico in modalità stand by:	-

Utilizzo sostenibile delle risorse naturali:

Informazioni sulla sostenibilità ambientale:	NPD
--	-----

Le prestazioni del prodotto sopra identificato sono conformi a tutte le prestazioni dichiarate. La presente dichiarazione di prestazione è rilasciata in conformità al Regolamento (UE) n. 305/2011, sotto la responsabilità del produttore sopra indicato.

Firmato da e per conto del produttore :

Ramon Roma Viñets

Centelles, 19/01/2026

Amministratore





Modell:	Laris 80 LI
Ref:	M7046
Bestimmungsgemäße Verwendung des Produkts:	Raumheizung in Wohngebäuden
Herstellernamen:	Manufacturas Rocal S.A
Herstelleradresse:	Raval Sant Antoni, 2, (08540) Centelles, España
AVCP-System:	System 3
Notifizierte Stelle:	Kiwa Cermet Italia
Harmonisierte technische Spezifikation:	EN 16510-1:2022, EN 16510-2-1:2022
Prüfberichtsnummer:	0476-AoP-CPR-2014280

Wesentliche Eigenschaften

Standsicherheit und mechanische Festigkeit

Tragfähigkeit: 0 kg

Brandschutz – Schutz brennbarer Elemente

Mindestabstand zu brennbaren Materialien – Boden (dB):	350 mm
Mindestabstand zu brennbaren Materialien – Vorderseite (dF):	1500 mm
Mindestabstand zu brennbaren Materialien – Decke (dC):	750 mm
Mindestabstand zu brennbaren Materialien – Rückseite (dR):	250 mm
Mindestabstand zu brennbaren Materialien – Seite (dS1):	900 mm
Mindestabstand zu brennbaren Materialien – Seite (dS2):	380 mm
Mindestabstand zu brennbaren Materialien - seitliche Strahlung (dL1):	0 mm
Mindestabstand zu brennbaren Materialien - seitliche Strahlung (dL2):	1500 mm
Mindestabstand zu brennbaren Materialien - Frontstrahlung (dP):	1100 mm
Dicke des isolierenden Schutzmaterials:	-
Wärmeleitfähigkeit des isolierenden Schutzmaterials (Ad):	-
Rauchrohrklasse:	T400G

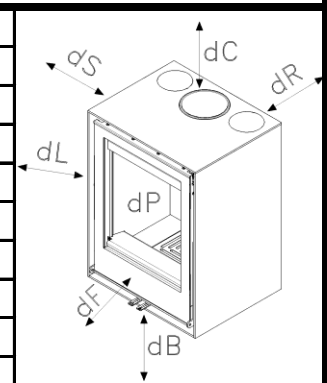

Leistung - Emissionen:

Leistung - Emissionen

Reduzierte Leistung

Carbonmonoxid (CO bei 13 % von O ₂):	907 mg/m ³	2781 mg/m ³
Stickoxide (NOx bei 13 % von O ₂):	99 mg/m ³	89 mg/m ³
Flüchtige organische Verbindungen (VOC bei 13 % O ₂):	47 mg/m ³	230 mg/m ³
Staubemission (PM bei 13 % O ₂):	14 mg/m ³	30 mg/m ³

Leistung – Heizleistung und Effizienz:

Leistung - Emissionen

Reduzierte Leistung

Nennwärmeleistung an den Raum:	6,90 kW	4,60 kW
Wirkungsgrad:	86,8 %	80,3 %

Daten zur Schornsteininstallation:

Leistung - Emissionen

Reduzierte Leistung

Rauchgastemperatur:	244,4 °C	234,8 °C
Mindestzug:	11,7 Pa	11,4 Pa
Massenstrom:	4,7 g/s	-

Raumheizungswirkungsgrad

Saisonaler Wirkungsgrad:	77 %
Energieeffizienzindex:	116
Energieklassifizierung:	A+
Elektrischer Verbrauch bei Nennleistung:	-
Elektrischer Verbrauch bei reduzierter Leistung:	-
Elektrischer Verbrauch im Standby:	-

Nachhaltige Nutzung natürlicher Ressourcen:

Informationen zur ökologischen Nachhaltigkeit:	NPD
--	-----

Die Leistung des oben genannten Produkts entspricht allen deklarierten Leistungsdaten. Diese Leistungserklärung wird gemäß Verordnung (EU) Nr. 305/2011 unter der Verantwortung des oben genannten Herstellers abgegeben.

Unterzeichnet vom Hersteller bzw. in dessen Auftrag durch:

Ramon Roma Viñets

Centelles, 19/01/2026

Amministrador